

kfi STUDIOS Eos Micro Table Lamp

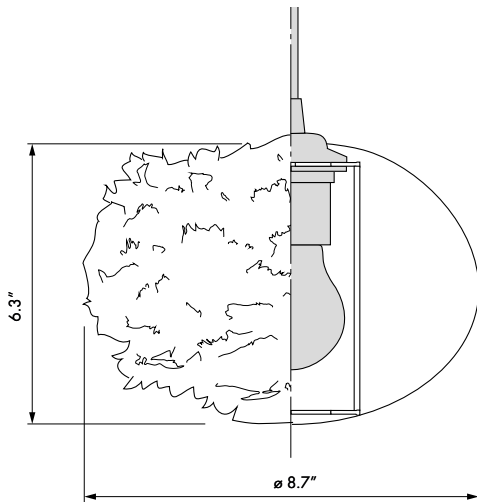

Designed by Soren Ravn Christensen in Copenhagen, Denmark



Pendant, wall & table lamp



Dimensions

ø 8.7"
h 6.3"



Material

Approx 500 goose feathers , fabric and steel



Easily cleaned with hairdryer



Weight

0.25 lbs



Light source

E26 - max 15 W LED



Packaging

Gift Box, Dimensions 9.06 * 9.06 * 3.15" (LxWxH)



Assembly time

5 min



Ordering Information

Eos Micro Table Lamp

White with White Tripod Base	3000_4055
White with Black Tripod Base	3000_4056
Light Grey with White Tripod Base	3012_4055
Light Grey with Black Tripod Base	3012_4056
Light Brown with White Tripod Base	3014_4055
Light Brown with Black Tripod Base	3014_4056

Color variations



White



Light grey



Light brown

kfi STUDIOS Eos Mini Table Lamp



Designed by Soren Ravn Christensen in Copenhagen, Denmark

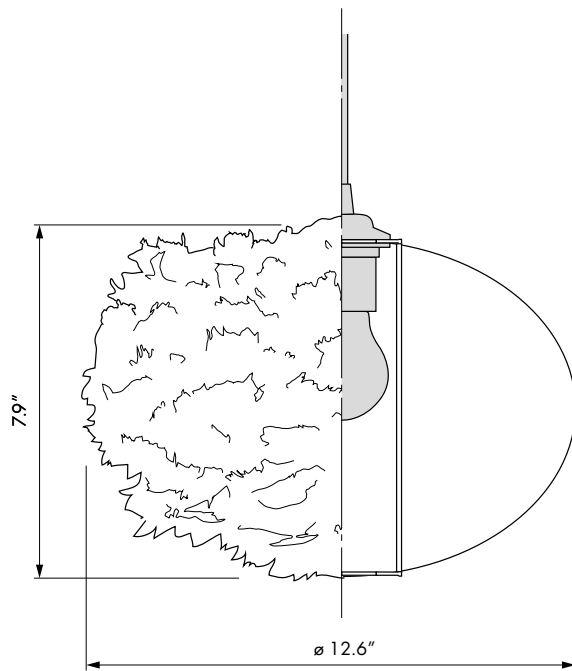

Pendant, wall & table lamp



Dimensions

ø 12.6"
h 7.9"



Material

Approx 900 goose feathers, paper and steel



Easily cleaned with hairdryer



Weight

0.4 lbs



Light source

E26 - max 15 W LED



Packaging

Gift Box, Dimensions (L×W×H): 11.8×11.8×3.5"



Assembly time

15 min

Ordering Information

Eos Mini Table Lamp

White with White Tripod Base	3001_4023
White with Black Tripod Base	3001_4024
Light Grey with White Tripod Base	3013_4023
Light Grey with Black Tripod Base	3013_4024
Light Brown with White Tripod Base	3015_4023
Light Brown with Black Tripod Base	3015_4024

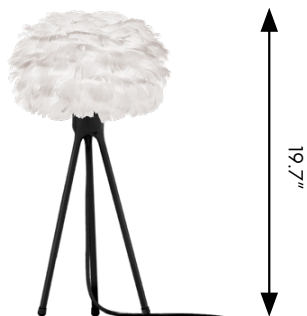

Eos mini + Tripod table

Color variations



White



Light grey



Light brown

kfi STUDIOS Eos Medium Table Lamp UMAGE

Designed by Soren Ravn Christensen in Copenhagen, Denmark

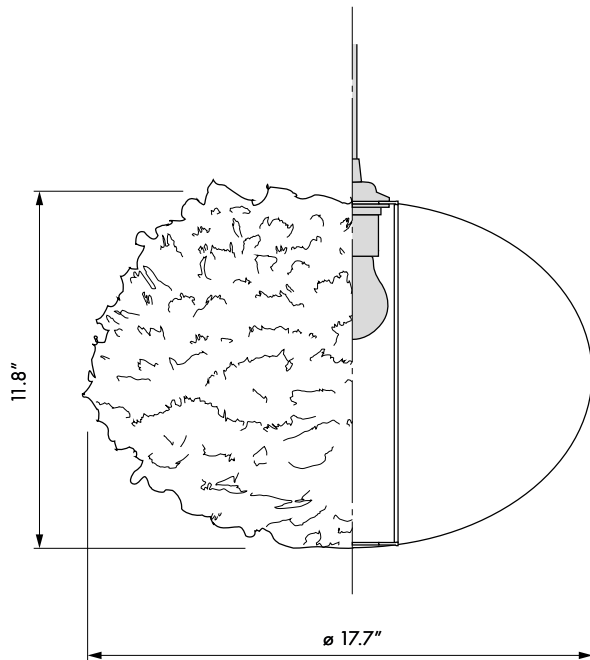

Pendant, wall, floor & table lamp



Dimensions

ø 17.7"
h 11.8"



Material

Approx 1,800 goose feathers, paper and steel



Easily cleaned with hairdryer



Weight

0.6 lbs



Light source

E26 - max 15 W LED



Packaging

Gift Box, Dimensions (L×W×H): 15.7×15.7×3.5"



Assembly time

5 min -

Ordering Information

Eos Medium Table Lamp

White with White Tripod Base	3002_4023
White with Black Tripod Base	3002_4024
Light Grey with White Tripod Base	3009_4023
Light Grey with Black Tripod Base	3009_4024
Light Brown with White Tripod Base	3006_4023
Light Brown with Black Tripod Base	3006_4024



Eos medium + Tripod table

Color variations



White



Light brown



Light grey

kfi STUDIOS Eos Medium Floor Lamp UMAGE

Designed by Soren Ravn Christensen in Copenhagen, Denmark

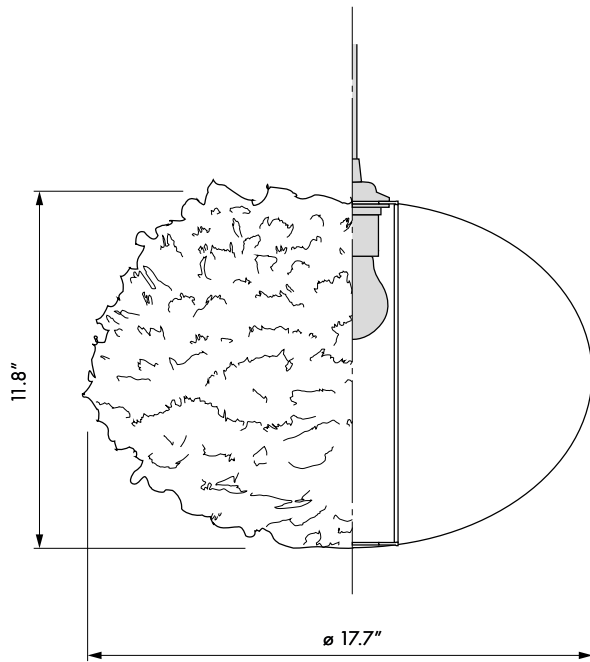



 **Pendant, wall, floor & table lamp**

 **Dimensions**
 ø 17.7"
 h 11.8"

 **Material**
 Approx 1,800 goose feathers, paper and steel

 **Easily cleaned with hairdryer**

 **Weight**
 0.6 lbs

 **Light source**
 E26 - max 15 W LED

 **Packaging**
 Gift Box, Dimensions (L×W×H): 15.7×15.7×3.5"

 **Assembly time**
 5 min -

Ordering Information

Eos Medium Floor Lamp

White with White Tripod Base	3002_4037
White with Black Tripod Base	3002_4038
Light Grey with White Tripod Base	3009_4037
Light Grey with Black Tripod Base	3009_4038
Light Brown with White Tripod Base	3006_4037
Light Brown with Black Tripod Base	3006_4038



Color variations



White



Light brown



Light grey

kfi STUDIOS Eos Large Floor Lamp



Designed by Soren Ravn Christensen in Copenhagen, Denmark

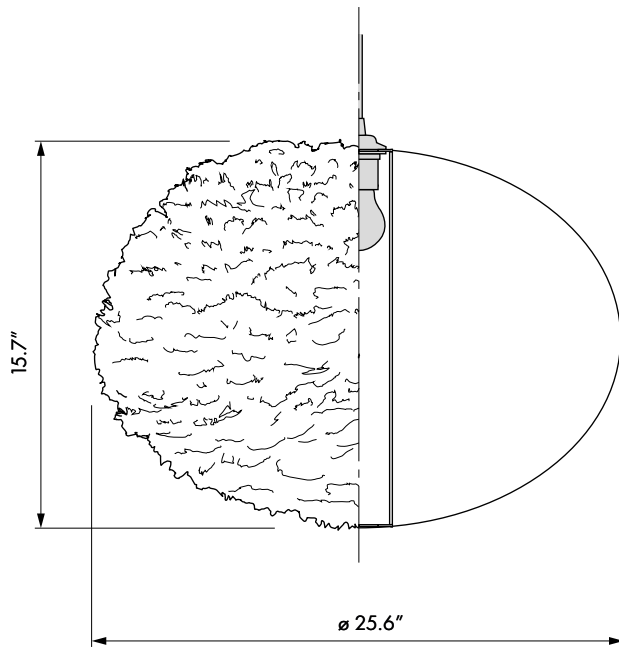

Eos large + champagne

Color variations



White

Light grey

Light brown



Pendant, wall, floor & table lamp



Dimensions

ø 25.6"
h 15.7"



Material

Approx 4,500 goose feathers, paper and steel



Easily cleaned with hairdryer



Weight

1.2 lbs



Light source

E26 - max 15 W LED



Packaging

Gift Box, Dimensions (L×W×H): 9.85x9.85x25.6"



Assembly time

5 min -

Ordering Information

Eos Large Floor Lamp

White with White Tripod Base	3003_4037
White with Black Tripod Base	3003_4038
Light Grey with White Tripod Base	3010_4037
Light Grey with Black Tripod Base	3010_4038
Light Brown with White Tripod Base	3007_4037
Light Brown with Black Tripod Base	3007_4038

kfi STUDIOS Eos Micro Pendant



Designed by Soren Ravn Christensen in Copenhagen, Denmark

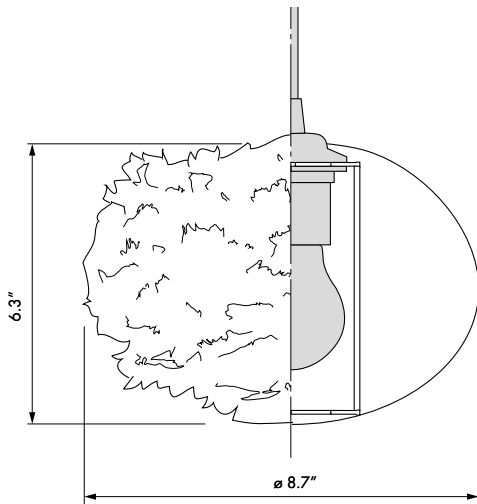

Eos Micro Canopy



Eos Micro Plug-In

Color variations



White



Light grey



Light brown



Pendant, wall & table lamp



Dimensions

ø 8.7"
h 6.3"



Material

Approx 500 goose feathers , fabric and steel



Easily cleaned with hairdryer



Weight

0.25 lbs



Light source

E26 - max 15 W LED



Packaging

Gift Box, Dimensions 9.06 * 9.06 * 3.15" (LxWxH)



Assembly time

5 min

Ordering Information

Eos Micro with Canopy Cord Set

White with White	3000_4007
White with Black	3000_4008
Light Grey with White	3012_4007
Light Grey with Black	3012_4008
Light Brown with White	3014_4007
Light Brown with Black	3014_4008

Eos Micro with Plug-In Cord Set

White with White	3000_4009
White with Black	3000_4010
Light Grey with White	3012_4009
Light Grey with Black	3012_4010
Light Brown with White	3014_4009
Light Brown with Black	3014_4010

kfi STUDIOS Eos Mini Pendant



Designed by Soren Ravn Christensen in Copenhagen, Denmark

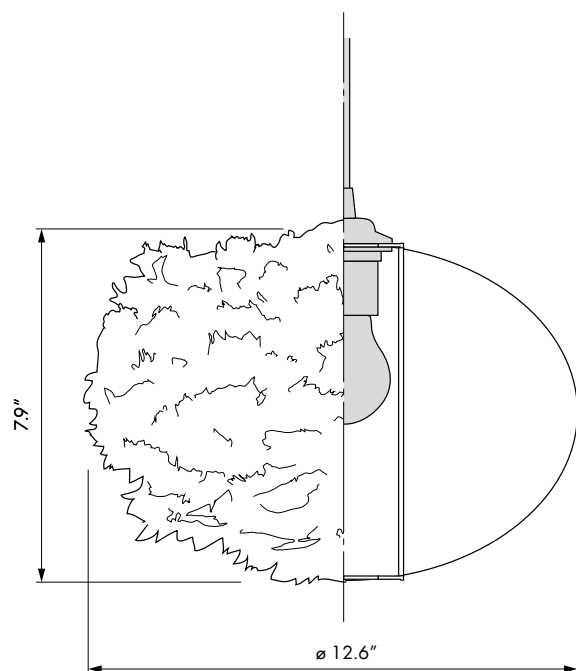

Eos Mini Canopy



Eos Mini Plug-In

Color variations



White



Light grey



Light brown



Pendant, wall & table lamp



Dimensions

ø 12.6"
h 7.9"



Material

Approx 900 goose feathers, paper and steel



Easily cleaned with hairdryer



Weight

0.4 lbs



Light source

E26 - max 15 W LED



Packaging

Gift Box, Dimensions (L×W×H): 11.8×11.8×3.5"



Assembly time

15 min

Ordering Information

Eos Mini with Canopy Cord Set

White with White	3001_4007
White with Black	3001_4008
Light Grey with White	3013_4007
Light Grey with Black	3013_4008
Light Brown with White	3015_4007
Light Brown with Black	3015_4008

Eos Mini with Plug-In Cord Set

White with White	3001_4009
White with Black	3001_4010
Light Grey with White	3013_4009
Light Grey with Black	3013_4010
Light Brown with White	3015_4009
Light Brown with Black	3015_4010

kfi STUDIOS Eos Medium Pendant

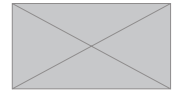

Designed by Soren Ravn Christensen in Copenhagen, Denmark

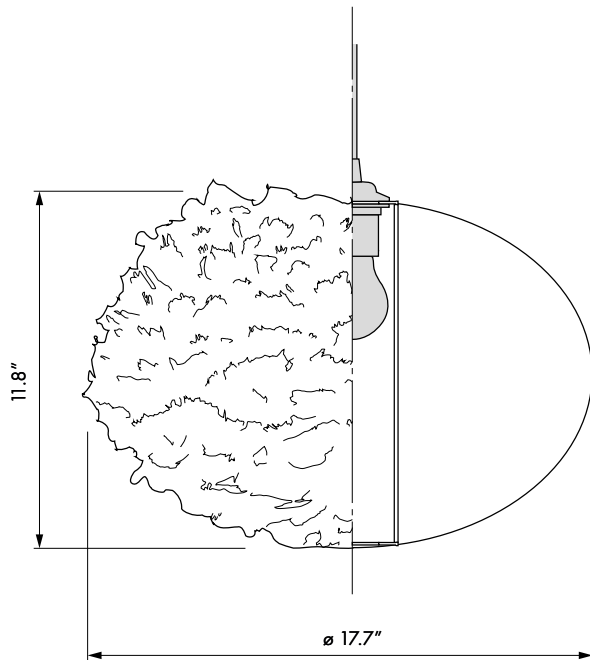

Eos Medium Canopy



Eos Medium Plug-In

Color variations



White



Light brown



Light grey



Pendant, wall, floor & table lamp



Dimensions

ø 17.7"
h 11.8"



Material

Approx 1,800 goose feathers, paper and steel



Easily cleaned with hairdryer



Weight

0.6 lbs



Light source

E26 - max 15 W LED



Packaging

Gift Box, Dimensions (L×W×H): 15.7×15.7×3.5"



Assembly time

5 min -

Ordering Information

Eos Medium with Canopy Cord Set

White with White	3001_4007
White with Black	3001_4008
Light Grey with White	3013_4007
Light Grey with Black	3013_4008
Light Brown with White	3015_4007
Light Brown with Black	3015_4008

Eos Medium with Plug-In Cord Set

White with White	3001_4009
White with Black	3001_4010
Light Grey with White	3013_4009
Light Grey with Black	3013_4010
Light Brown with White	3015_4009
Light Brown with Black	3015_4010

kfi STUDIOS Eos Large Pendant



Designed by Soren Ravn Christensen in Copenhagen, Denmark

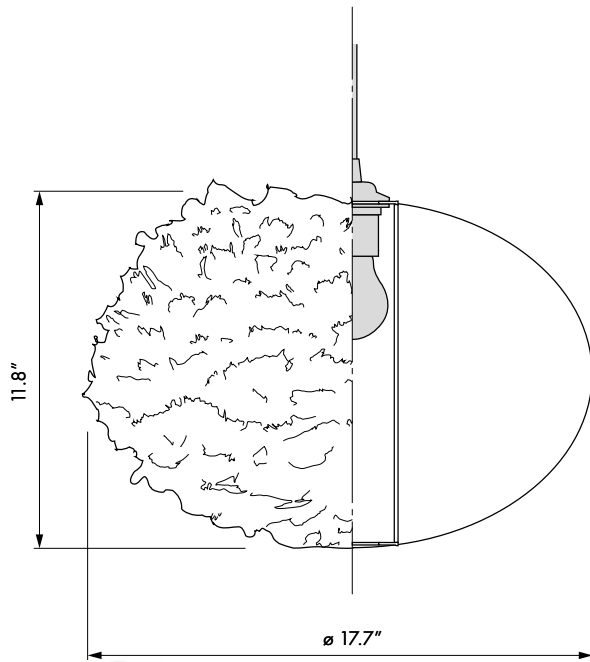

Eos Large Canopy



Eos Large Plug-In

Color variations



White



Light brown



Light grey



Pendant, wall, floor & table lamp



Dimensions

ø 17.7"
h 11.8"



Material

Approx 1,800 goose feathers, paper and steel



Easily cleaned with hairdryer



Weight

0.6 lbs



Light source

E26 - max 15 W LED



Packaging

Gift Box, Dimensions (L×W×H): 15.7×15.7×3.5"



Assembly time

5 min -

Ordering Information

Eos Large with Canopy Cord Set

White with White	3003_4007
White with Black	3003_4008
Light Grey with White	3010_4007
Light Grey with Black	3010_4008
Light Brown with White	3007_4007
Light Brown with Black	3007_4008

Eos Large with Plug-In Cord Set

White with White	3003_4009
White with Black	3003_4010
Light Grey with White	3010_4009
Light Grey with Black	3010_4010
Light Brown with White	3007_4009
Light Brown with Black	3007_4010

kfi STUDIOS Eos XLarge Pendant



Designed by Soren Ravn Christensen in Copenhagen, Denmark

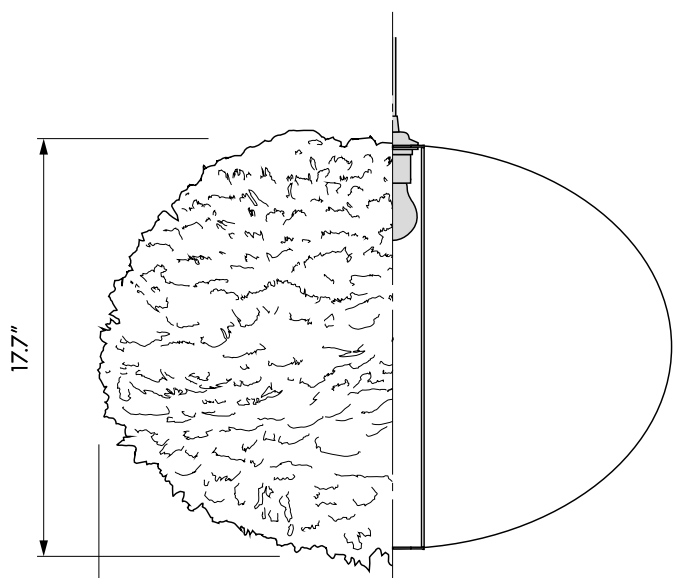

Pendant

Dimensions

∅ 29.5"
h 17.7"

Material

Approx 6,000 goose feathers, paper and steel

Easily cleaned with hairdryer

Weight

2 lbs

Light source

E26 - max 15 W LED

Packaging

Gift Box, Dimensions (L×W×H): 9.8x9.8x29.5"

Assembly time

5 min -

Ordering Information

Eos XLarge with Canopy Cord Set

White with White	3004_4007
White with Black	3004_4008
Light Grey with White	3011_4007
Light Grey with Black	3011_4008
Light Brown with White	3008_4007
Light Brown with Black	3008_4008

Eos XLarge with Plug-In Cord Set

White with White	3004_4009
White with Black	3004_4010
Light Grey with White	3011_4009
Light Grey with Black	3011_4010
Light Brown with White	3008_4009
Light Brown with Black	3008_4010



Eos XLarge Canopy

Eos XLarge Plug-In

Color variations



White

Light brown

Light grey

kfiSTUDIOS Eos XXLarge Pendant



Designed by Soren Ravn Christensen in Copenhagen, Denmark

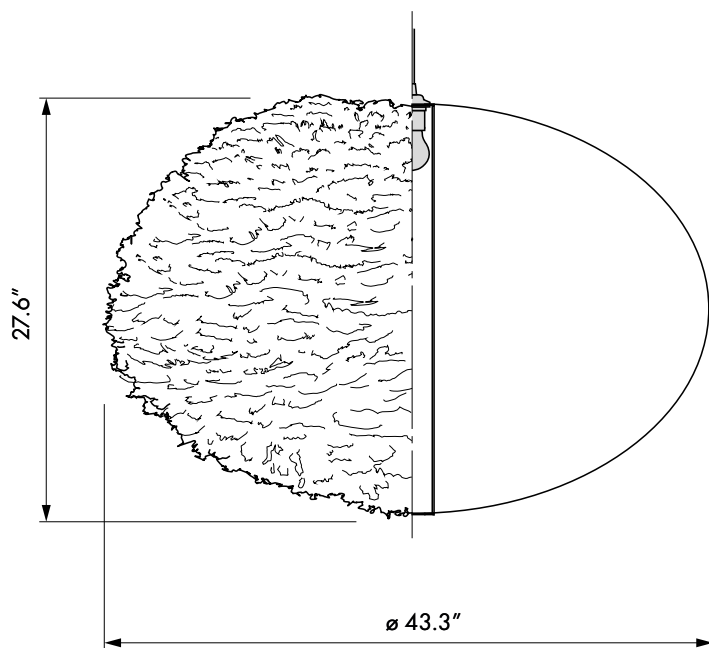

Pendant

Dimensions

∅ 43.3"
h 27.6"

Material

Approx 13,500 goose feathers, paper and steel



Easily cleaned with hairdryer



Weight

5.7 lbs



Light source

E26 - max 15 W LED



Packaging

Gift Box, Dimensions (L×W×H): 11.4x11.4x43.3"



Assembly time

5 min -

Ordering Information

Eos XLarge with Canopy Cord Set

White with White	3005_4007
White with Black	3005_4008

Eos XLarge with Plug-In Cord Set

White with White	3005_4009
White with Black	3005_4010



Eos XXLarge Canopy

Eos XXLarge Plug-In

Color variations



White

kfi STUDIOS Eos Up Sconce Small



Designed by Soren Ravn Christensen



Surface mounted lamp
Comes with 2 x E27



CERTIFICATION
CE (for indoor use), IP2X



Easily cleaned with hairdryer



DIMENSIONS
Ø: 15.7"
H: 5.9"



MATERIAL
Goose feathers, Fabric & Steel



WEIGHT INCL. PACKAGING
2.2 lb



LIGHT SOURCE
2 x Max 10W GU24 Base Bulb (LED or CFL)



PACKAGING
Gift box dimensions (W×H×D): 15.2" x 15.2" x 5.7"



ASSEMBLY TIME
15 min

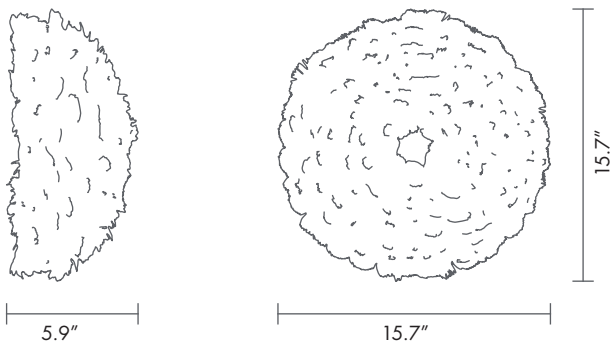

Ordering Information Eos Up Small Wall/Ceiling Sconce

White	2105
-------	------

Colour variations



White

kfi STUDIOS Eos Up Sconce Large



Designed by Soren Ravn Christensen



Surface mounted lamp
Comes with 2 x E27



CERTIFICATION
CE (for indoor use), IP2X



Easily cleaned with hairdryer



DIMENSIONS
Ø: 27.6"
H: 10.6"



MATERIAL
Goose feathers, Fabric & Steel



WEIGHT INCL. PACKAGING
5.7 lb



LIGHT SOURCE
2 x Max 10W GU24 Base Bulb (LED or CFL)



PACKAGING
Gift box dimensions (W×H×D): 27.6" x 27.6" x 5.9"



ASSEMBLY TIME
15 min

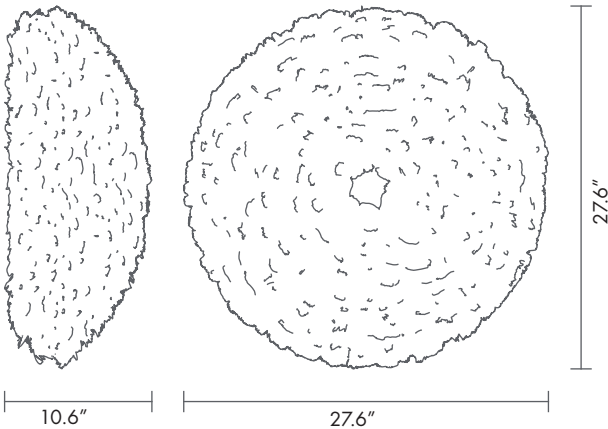

Ordering Information Eos Up Large Wall/Ceiling Sconce

White	3016
-------	------

Colour variations



White

kfi STUDIOS Eos Medium Wall Lamp



Designed by Soren Ravn Christensen in Copenhagen, Denmark

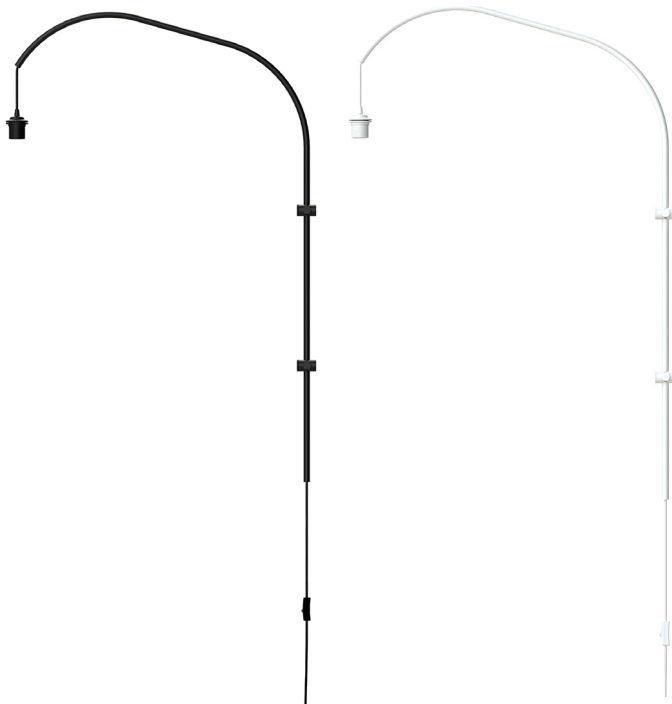
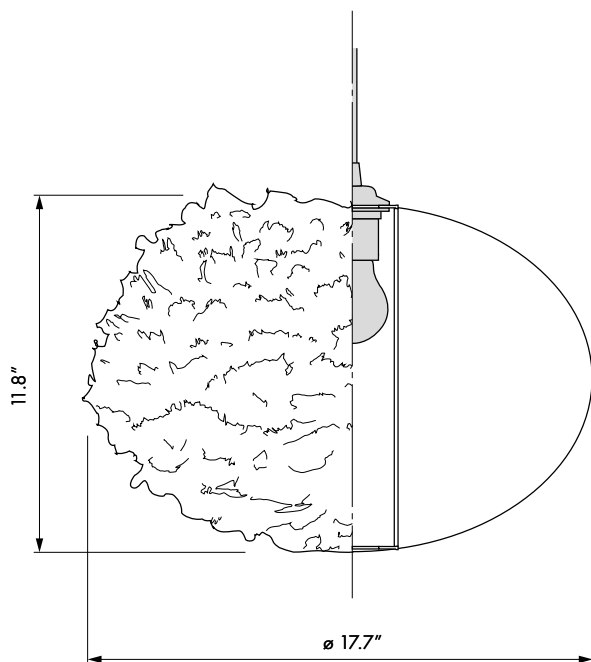

Color variations



White



Light brown



Light grey



Pendant, wall, floor & table lamp



Dimensions

ø 17.7"
h 11.8"



Material

Approx 1,800 goose feathers, paper and steel



Easily cleaned with hairdryer



Weight

0.6 lbs



Light source

E26 - max 15 W LED



Packaging

Gift Box, Dimensions (L×W×H): 15.7×15.7×3.5"



Assembly time

5 min -

Ordering Information

Eos Single Arm Wall Lamp

White with White	3002_4032
White with Black	3002_4033
Light Grey with White	3009_4032
Light Grey with Black	3009_4033
Light Brown with White	3006_4032
Light Brown with Black	3006_4033

kfiSTUDIOS Eos Large Wall Lamp



Designed by Soren Ravn Christensen in Copenhagen, Denmark

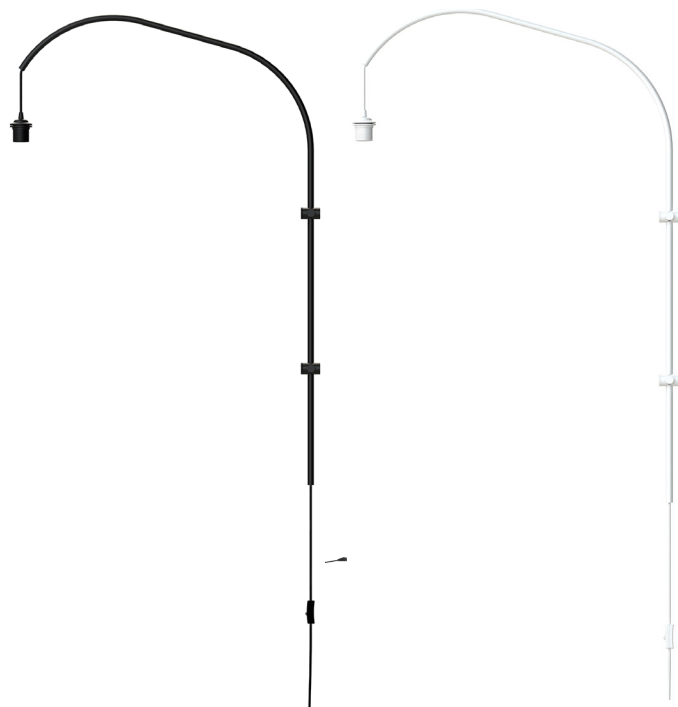
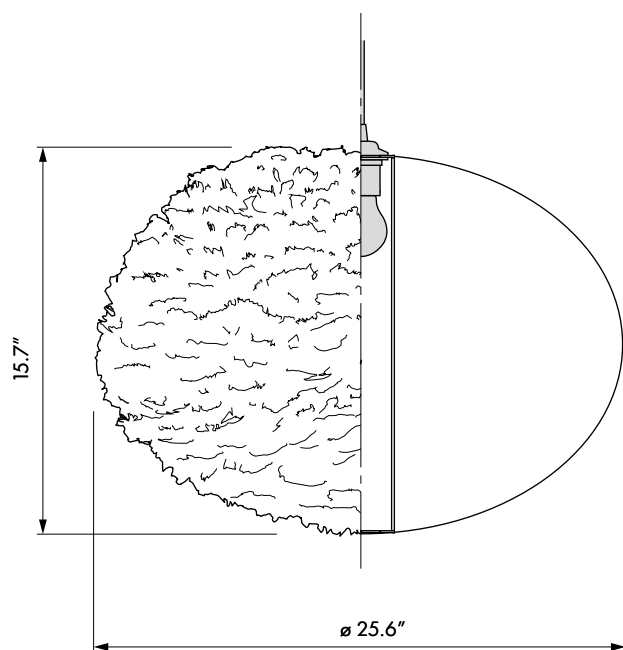

Color variations



White



Light grey



Light brown



Pendant, wall, floor & table lamp



Dimensions

ø 25.6"
h 15.7"



Material

Approx 4,500 goose feathers, paper and steel



Easily cleaned with hairdryer



Weight

1.2 lbs



Light source

E26 - max 15 W LED



Packaging

Gift Box, Dimensions (L×W×H): 9.85x9.85x25.6"



Assembly time

5 min -

Ordering Information

Eos Single Arm Wall Lamp

White with White	3003_4032
White with Black	3003_4033
Light Grey with White	3010_4032
Light Grey with Black	3010_4033
Light Brown with White	3007_4032
Light Brown with Black	3007_4033

kfi STUDIOS Eos Medium Wall Lamp



Designed by Soren Ravn Christensen in Copenhagen, Denmark

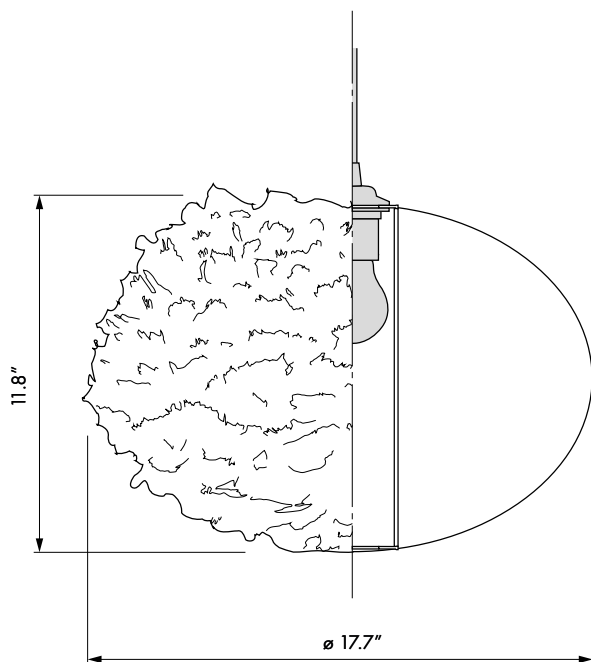

Color variations



White



Light brown



Light grey



Pendant, wall, floor & table lamp



Dimensions

ø 17.7"
h 11.8"



Material

Approx 1,800 goose feathers, paper and steel



Easily cleaned with hairdryer



Weight

0.6 lbs



Light source

E26 - max 15 W LED



Packaging

Gift Box, Dimensions (L×W×H): 15.7×15.7×3.5"



Assembly time

5 min -

Ordering Information

Eos Double Arm Wall Lamp

White with White	3002_4034
White with Black	3002_4035
Light Grey with White	3009_4035
Light Grey with Black	3009_4035
Light Brown with White	3006_4034
Light Brown with Black	3006_4035

kfiSTUDIOS Eos Large Wall Lamp



Designed by Soren Ravn Christensen in Copenhagen, Denmark

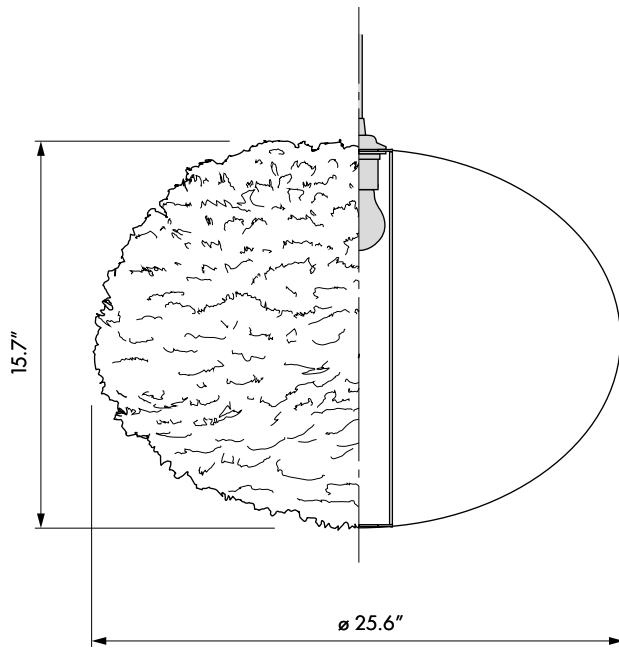

Color variations



White

Light grey

Light brown



Pendant, wall, floor & table lamp



Dimensions

ø 25.6"
h 15.7"



Material

Approx 4,500 goose feathers, paper and steel



Easily cleaned with hairdryer



Weight

1.2 lbs



Light source

E26 - max 15 W LED



Packaging

Gift Box, Dimensions (L×W×H): 9.85x9.85x25.6"



Assembly time

5 min -

Ordering Information

Eos Double Arm Wall Lamp

White with White	3002_4034
White with Black	3002_4035
Light Grey with White	3009_4035
Light Grey with Black	3009_4035
Light Brown with White	3006_4034
Light Brown with Black	3006_4035